

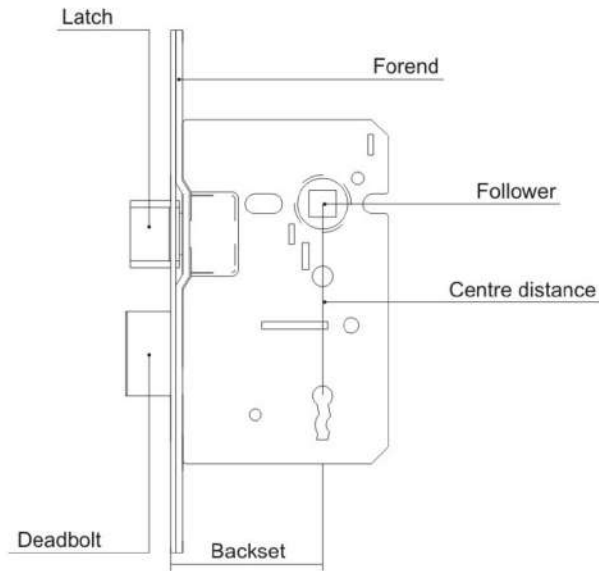











# Glossary of Lock



## Function Variations

- |   |   |   |   |
|---|---|---|---|
|  |  |  |  |
| Euro-profile cylinder lock  | key lock  | bathroom lock   | cross key lock  |
|  |  |  |  |
| oval cylinder lock  | reversible  | free handed   | fixed handed  |
|  |  |  |  |
| closed lockcase   | open lockcase   | round corner  | square corner   |



5 Lever Sash Lock

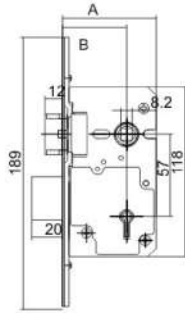

B(mm)	A(mm)
45	65
57	77

54.21



5 Lever Dead Lock

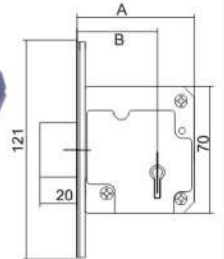

B(mm)	A(mm)
45	65
57	77

54.20



5 Lever Sash Lock Economic

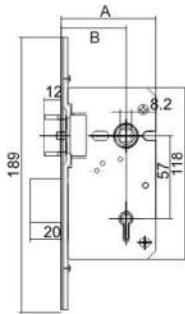

B(mm)	A(mm)
45	65
57	77

54.33



5 Lever Dead Lock Economic

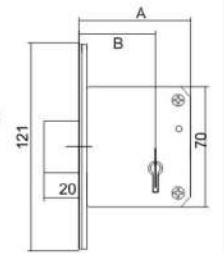

B(mm)	A(mm)
45	65
57	77

54.32



6 Lever Sash Lock

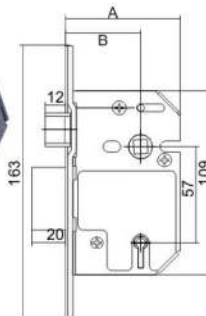

B(mm)	A(mm)
45	67
57	76

54.61



6 Lever Dead Lock

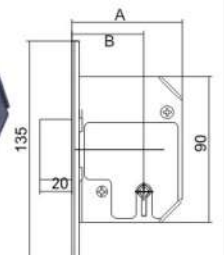

B(mm)	A(mm)
45	67
57	76

54.60



Heavy Duty Bathroom Lock



CE

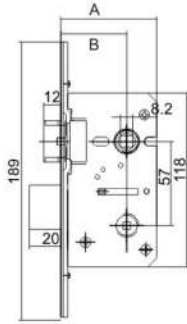

B(mm)	A(mm)
45	65
57	77

54.05



Heavy Duty Upright Latch



CE

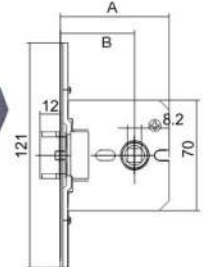

B(mm)	A(mm)
45	65
57	77

54.02



Heavy Duty Euro Sash Lock



CE

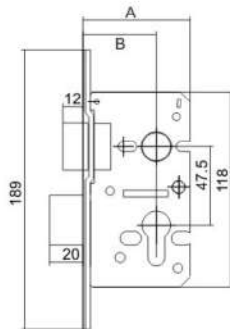

B(mm)	A(mm)
45	65
57	77

54.12



free handed

Heavy Duty Euro Dead Lock



CE

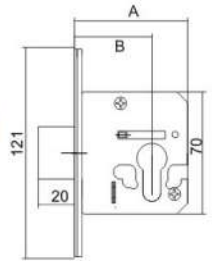

B(mm)	A(mm)
45	65
57	77

54.10



Euro Night Latch With Thumbturn



CE



54.14



Heavy Duty Tubular Latch



CE

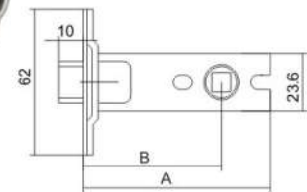

B(mm)	A(mm)
57	77
82	102
107	127

54.01



Mortice Bathroom Lock

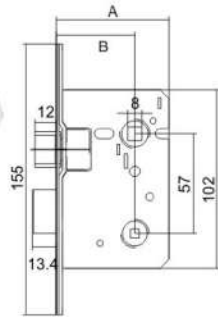

B(mm)	A(mm)
45	65
57	76

51.07



3Lever Mortice Sash Lock

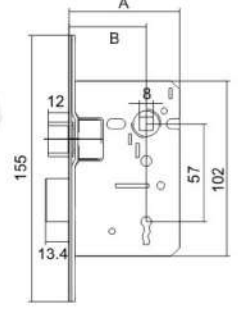

B(mm)	A(mm)
45	65
57	76

51.05



Mortice Bathroom Lock Economic

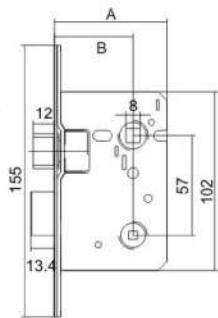

B(mm)	A(mm)
45	65
57	77

E-51.07



3Lever Mortice Sash Lock Economic

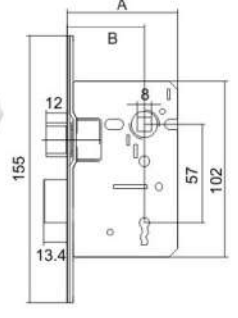

B(mm)	A(mm)
45	65
57	77

E-51.05



Bathroom Lock Low Value

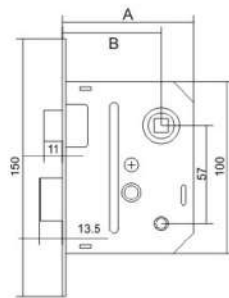

B(mm)	A(mm)
45	64
57	76

L-51.07



2 Lever Sash Lock

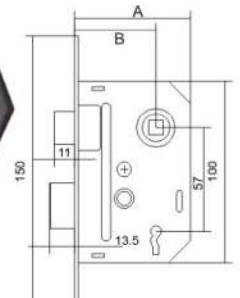

B(mm)	A(mm)
45	64
57	76

L-51.05



3Lever Mortice Dead Lock

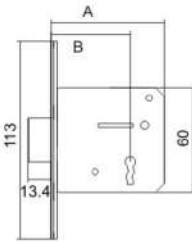

B(mm)	A(mm)
45	65
57	77

51.11



Euro Profile Sash Lock

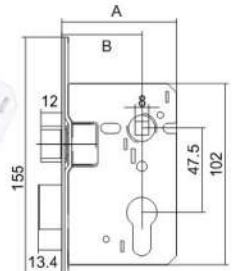

B(mm)	A(mm)
45	65
57	77

51.08



3Lever Mortice Dead Lock Economic

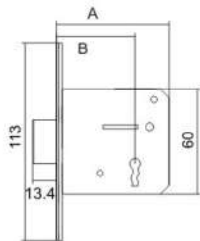

B(mm)	A(mm)
45	65
57	77

E-51.11



Euro Profile Dead Lock

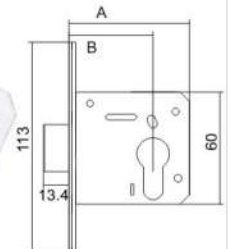

B(mm)	A(mm)
45	65
57	77

51.12



FB Deadlock

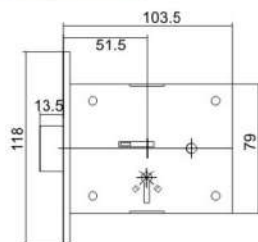

FB1/FB2



Upright Latch

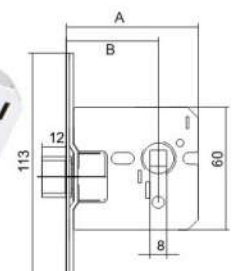

B(mm)	A(mm)
45	65
57	77

51.03





Traditional Cylinder Rim Nightlatch

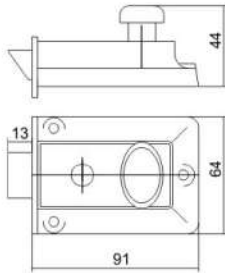

18.08



Rollerbolt Cylinder Rim Nightlatch

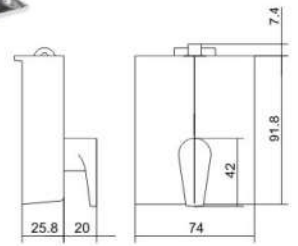

18.07



Magnetic Deadbolt

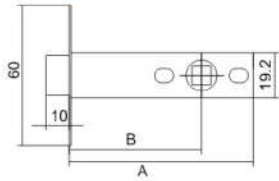

B(mm)	A(mm)
45	67
60	79

52.01M



Tubular Latch

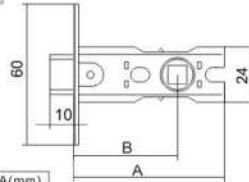

B(mm)	A(mm)
45	65
57	77
72	92

51.01

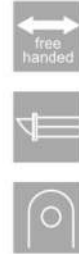

Tubular Latch Economic

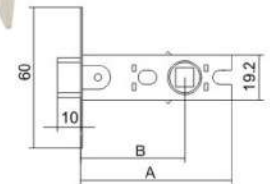

B(mm)	A(mm)
45	65
57	77
72	92

E-51.01



Deadbolt

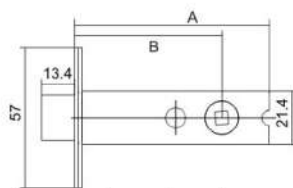

B(mm)	A(mm)
45	67
67	79

52.01



HD Adjustable Roller Catch

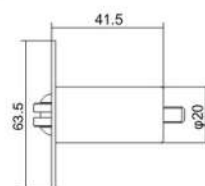

52.02

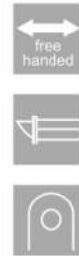

Security Bolt With Thumbturn

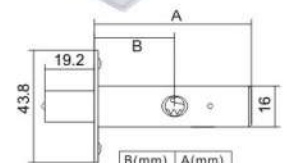

B(mm)	A(mm)
14.5	35
31.5	61
57	85.5

4.06&4.09



260

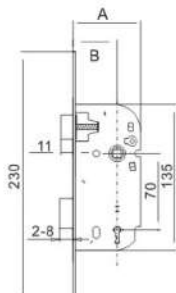

B(mm)	A(mm)
40	62.5
50	72.5



free handed



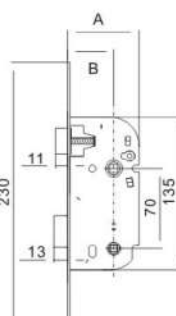





B(mm)	A(mm)
40	62.5
50	72.5



free handed

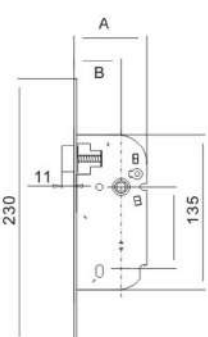





B(mm)	A(mm)
40	62.5
50	72.5



free handed

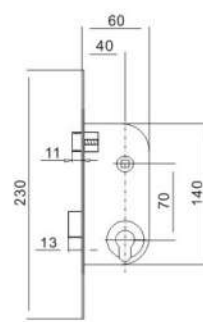
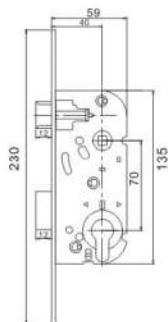



260X

2404C

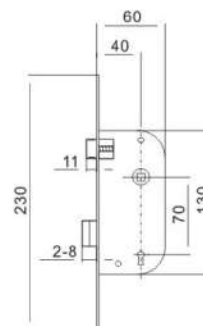
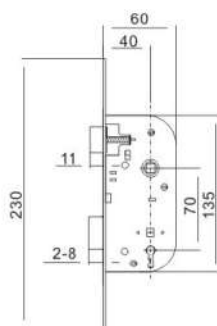
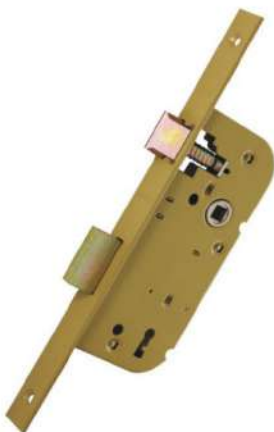

240L

2404

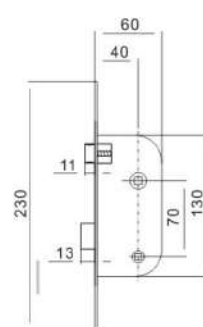
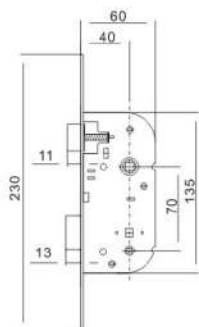

210L

2404B



B(mm)	A(mm)
40	70
50	80

B(mm)	A(mm)
40	70
50	80

3140C 320C

B(mm)	A(mm)
40	70
50	80

B(mm)	A(mm)
40	70
50	80

3140K 320K

B(mm)	A(mm)
40	70
50	80

B(mm)	A(mm)
40	70
50	80

3140B 320B



9458

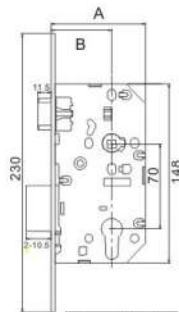

B(mm)	A(mm)
40	68
50	78

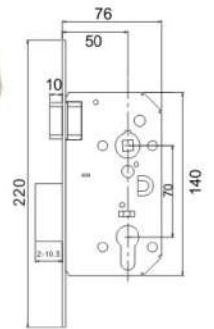

9458A

0750



9458AK

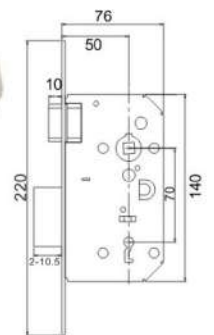
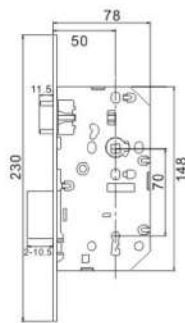

0750K



9458AB

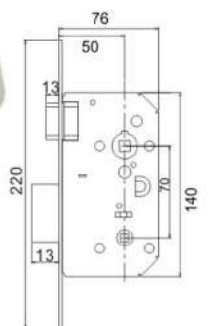
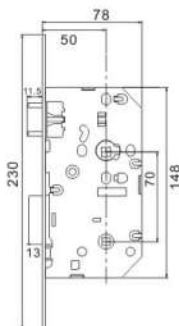

0750B

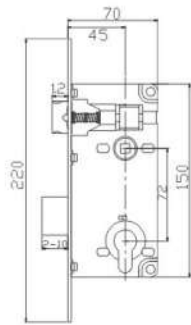

5072C

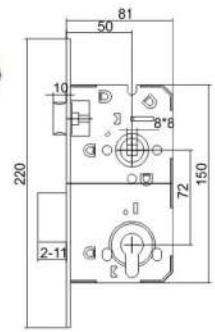

9040C

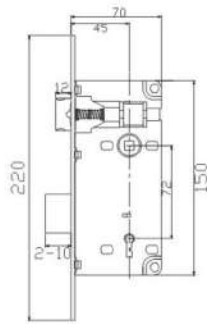

5072K



9040B

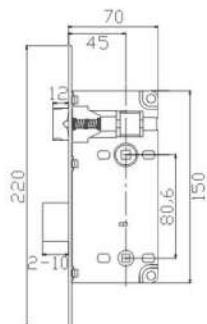

5072B



9040K

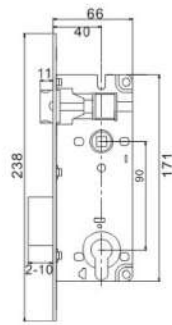

3090C

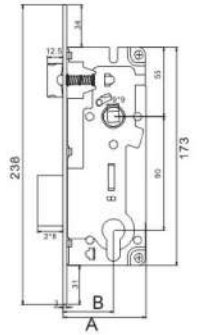

B(mm)	A(mm)
40	66
50	76

940C

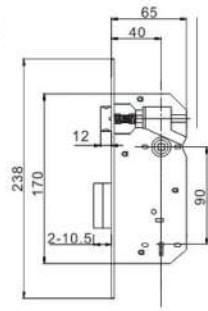

3090K

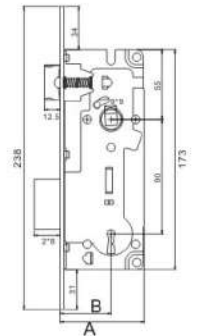

B(mm)	A(mm)
40	66
50	76

940K



3090B

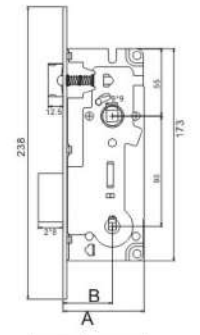

B(mm)	A(mm)
40	66
50	76

940B

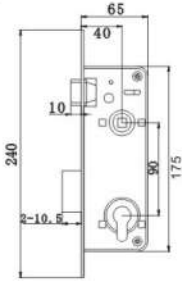

4090C

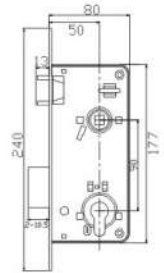

5090C

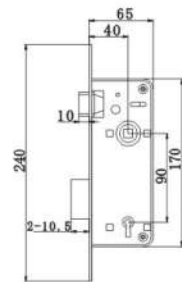

4090K

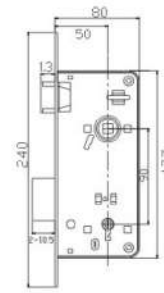
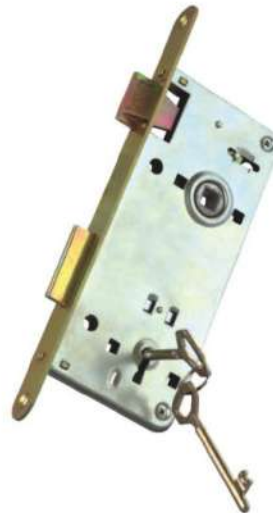

5090K

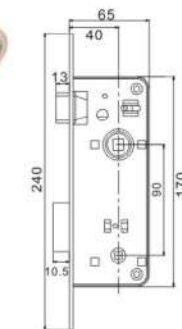

4090B

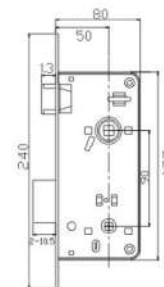
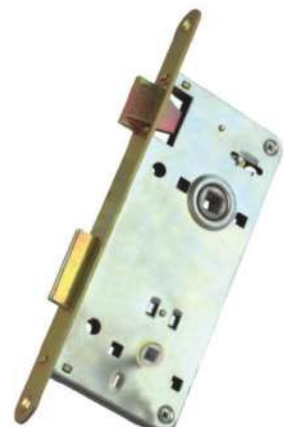

5090B



# LOCK BODY

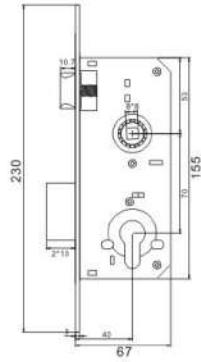

6470C

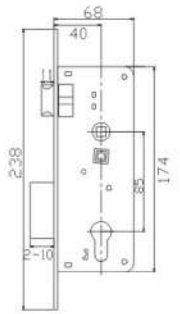

4085C

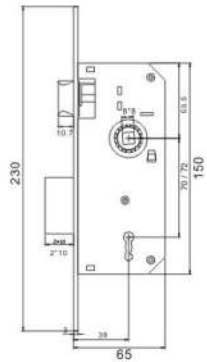

6470K

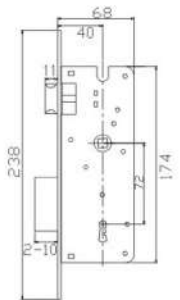

4072K

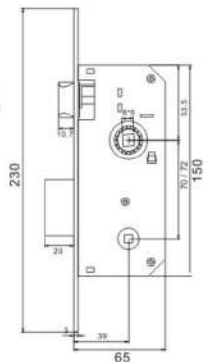

6470B

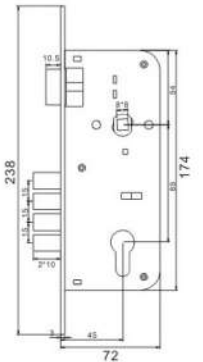

4585-III

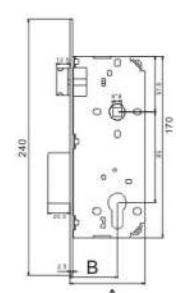
B(mm)	A(mm)
40	65.5
45	70.5
50	75.5

7435-40/45/50
6005

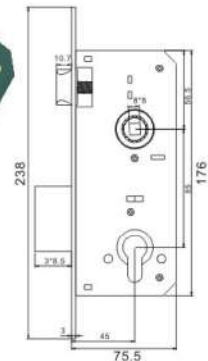

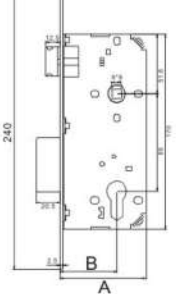

B(mm)	A(mm)
40	65.5
45	70.5
50	75.5

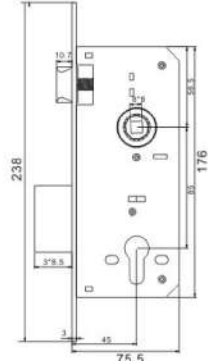

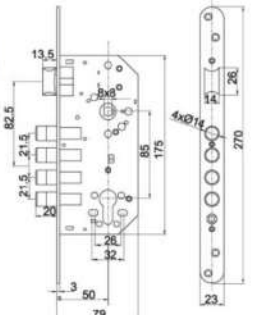

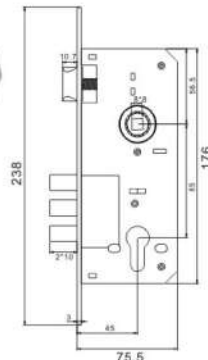
7435A-40/45/50
6005A



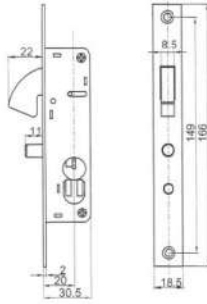

R2000A
6010



1582P

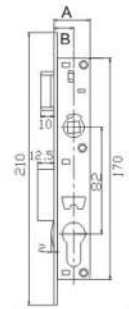

B(mm)	A(mm)
15.5	28
25.5	40.5

901

1582C

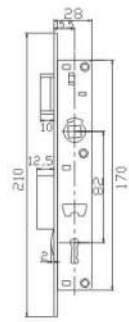
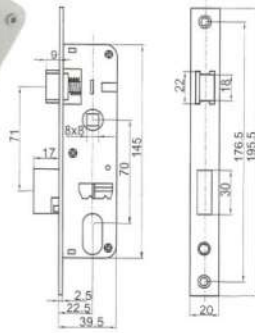

602

1582K

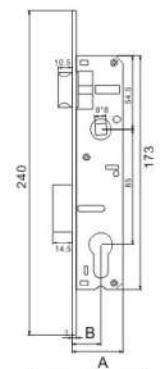
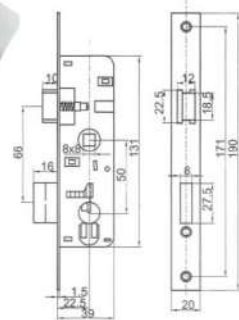

B(mm)	A(mm)
21	37.5
25	41.5
30	46.5
35	51.5

605

2585

410SHO

410SPO

410SH

410SP

41055

41055A

free handed

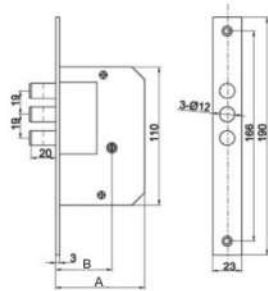

B(mm)	A(mm)
45	71.5
50	86

189-3

free handed

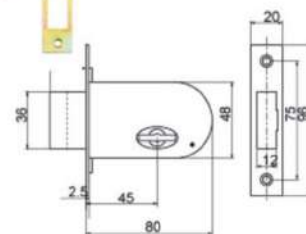

700K

free handed

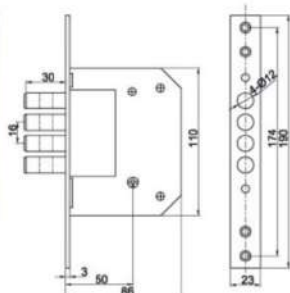

189-4

free handed

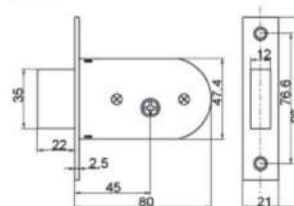

900A

free handed

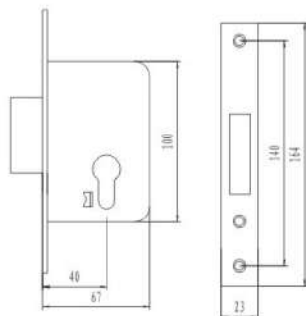

6040

free handed

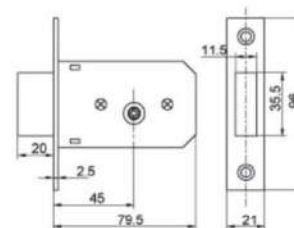

900AF





### Hook lock for sliding door



4120B

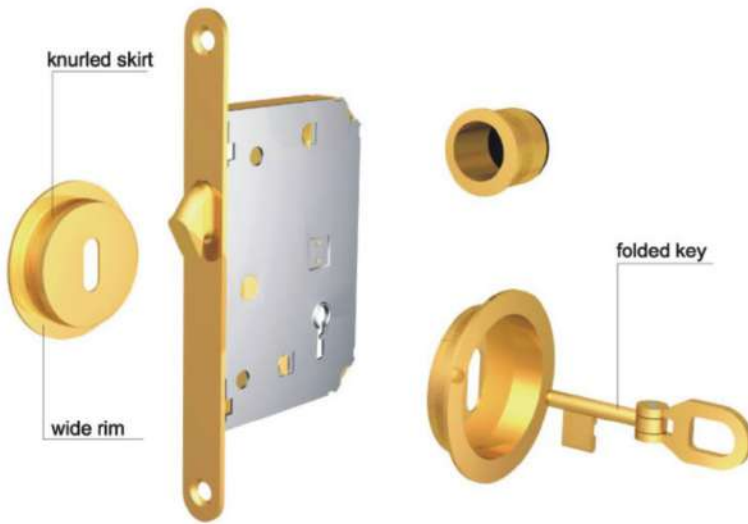
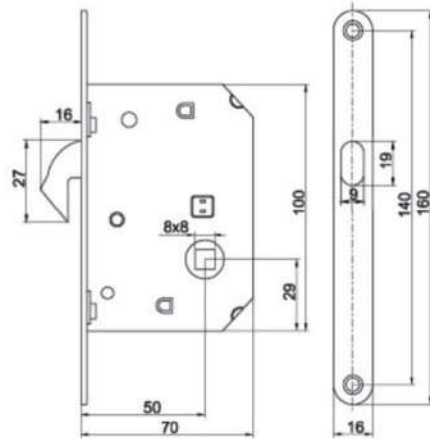

knurled skirt

wide rim

folded key

4120K

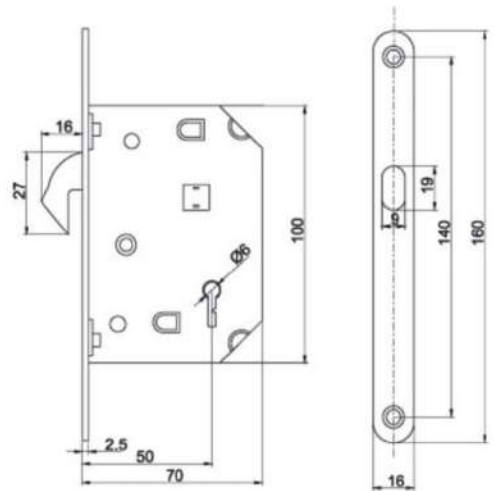

Square rose also available

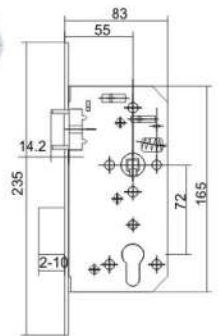
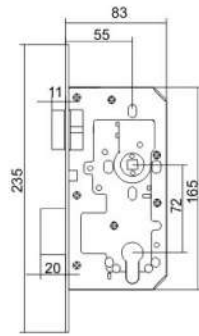

7255 Escape

7255

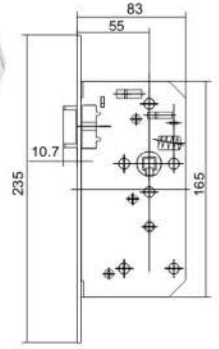
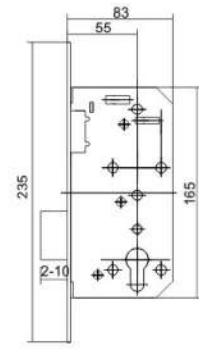

7255 dead

7255 latch

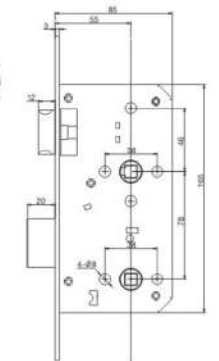
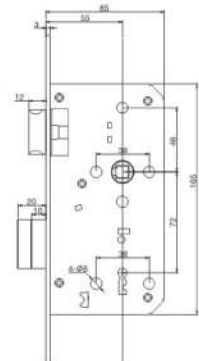

5572ZY

5578BK